

Diritti riservati All rights reserved

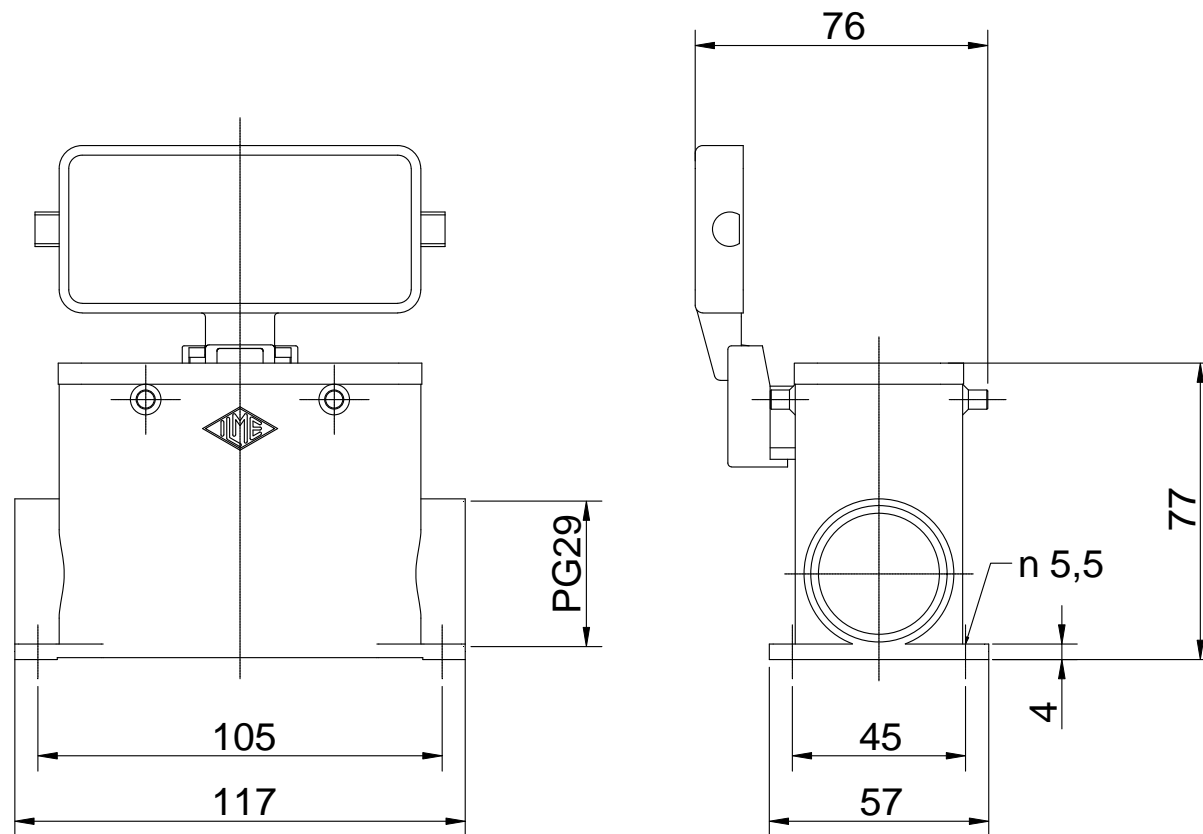

Date 04.01.2007	CMAP 06 CP29		Scale
Sign.	surface mount.h.pegs and cov. PG29 ins.		1:2
			